











Jolly

la zanzariera che rende libero il passaggio

COLORI ALLUMINIO





RAL Standard

-  01 Bianco
Semi Lucido
-  02 Avorio
1013
Semi Lucido
-  03 Marrone
8017
Semi Lucido
-  40 Marrone
8017
Ruvido
-  41 Verde
6009
Ruvido
-  06 Nero
9005
Opaco
-  08V
Bronzo
Verniciato
-  09
Argento
OX

Marmo + 10%

-  12 Grigio
Marmo

Legno + 40%

-  18
Noce
Ruvido
-  21
Douglas
Ruvido
-  22
Renolit
Chiaro
-  44
Renolit
Scuro

Colori Accessori

-  Nero

BREVETTO RM20130136

Jolly è un'elegante zanzariera ad avvolgimento laterale, ideale per porte-finestre: è dotata di presa ergonomica lungo tutto il profilo della barra maniglia, che ne rende comodo e facile l'azionamento sia dall'interno che dall'esterno.

L'apertura a chiusura dell'anta, pur essendo dotata di molla, risulta molto controllata, senza causare avvolgimenti improvvisi e veloci.

L'assenza di barriera al pavimento, rende il prodotto ideale per vani di frequente passaggio. Fissaggio rapido con clip a baionetta.



NEW

COMPENSATORE
TELESCOPICO CON
REGISTRO

NEW

Permette di compensare differenze in larghezza fino a 14 mm mantenendo il cassonetto sempre perpendicolare al pavimento.

MISURE CONSIGLIATE (mm)

| | | L | H | | | L | H |
|----------|------|------|------|----------|------|------|------|
| UN' ANTA | | - | 1400 | DUE ANTE | MIN. | - | 1400 |
| | MAX. | 1400 | 2800 | | MAX. | 2800 | 2800 |

SEZIONI

SEZ. ORIZZONTALE

SEZ. VERTICALE

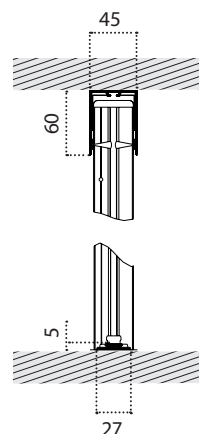
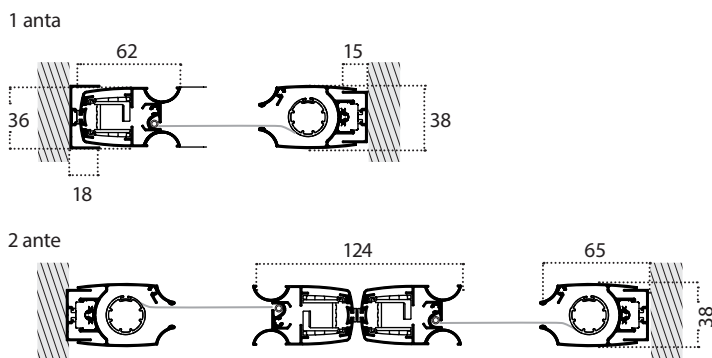

BLOCCO TELO CON ARPIONE

All'interno della catena la presenza di un arpione rotante, munito di lamelle di gomma, garantisce la tenuta del telo nella guida inferiore.

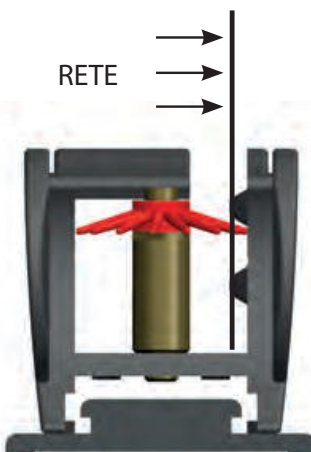

La guida a terra, grazie a un particolare sistema di aggancio, impedisce ai cingoli di sollevarsi in caso di vento.



ATTENZIONE RETE NON ALLINEATA

JOLLY A 2 ANTE

APERTURA SX

APERTURA DX



JOLLY CON DUE FINESTRE VICINE CON APERTURE OPPOSITE

APERTURA SX

APERTURA DX





ROMA

Via di Vigna Giarelli, 61/63 - ☎06.6538748

POMEZIA

Via Sassuolo, 1 - ☎06.9105952

✉ info@gruppo-far.it