

Il profilo Fissaggio Frontale permette di installare frontalmente la zanzariera modello Baby Plissè. Le dimensioni devono essere trasmesse in mm indicando base x altezza con le seguenti indicazioni.

✓ **MISURA FINITA:** Il profilo del fissaggio frontale verrà fornito con le dimensioni massimo ingombro, la zanzariera verrà fornita con dimensioni ridotte in relazione alla versione richiesta.

Esempio: misura max ingombro, la zanzariera verrà fornita con dimensioni ridotte di 30 mm in larghezza e 30 mm di altezza.

VERSIONI VISTE DALL'ESTERNO

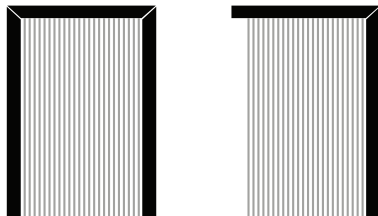

"A"

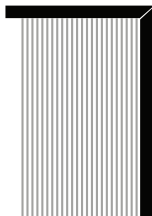

"B"

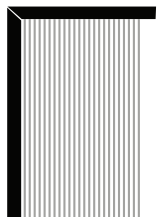

"C"

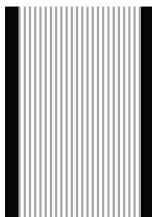

"D"

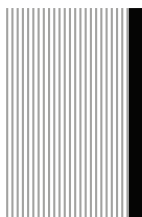

"E"

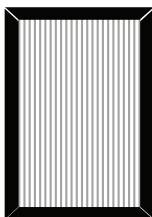

"F"

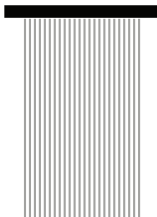

"G"

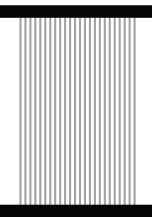

"H"

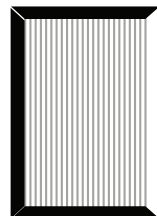

"I"

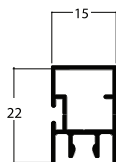

FISSAGGIO CON VITE
SEZ. ORIZZONTALE

Misura max ingombro

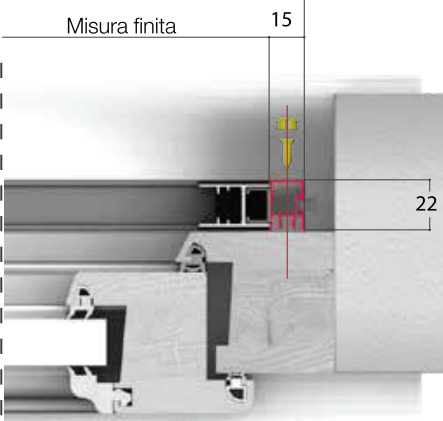

COLORI ALLUMINIO

RAL Standard

- 01 Bianco 9010 Semi Lucido
- 02 Avorio 1013 Semi Lucido
- 03 Marrone 8017 Semi Lucido
- 08V Bronzo Verniciato
- 09 Argento OX
- 06 Nero 9005 Opaco
- 12 Grigio Marmo

GF22-Kit Baby Plissè Fissaggio Frontale

fissaggio frontale

